

owner's manual

ple730r
ple520p

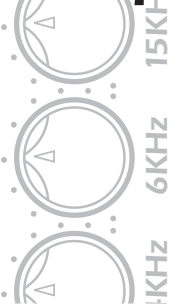

equalizer with subwoofer crossover



PYLE[®] plus

congratulations . . .

for choosing Pyle Audio, and congratulations on joining a select group of dedicated enthusiasts committed to the very best in mobile sound performance and dependability.

You are now the proud owner of one of the world's most sophisticated electronics components. This Pyle product is the result of an extensive engineering program with the sole purpose of creating the finest mobile audio experience imaginable. We're confident that this product will provide you with many years of outstanding musical entertainment.

Ple730r



table of contents

Ple520p



i	congratulations
1	table of contents
2	general features
3	specifications
	features and controls
4-5	Ple730r
6-7	Ple520p
8	mounting and installation
9	electrical connections
10-11	system wiring
12	precautions and troubleshooting

general features

ple730r

ple520p



- night illumination
- remote power on/off
- high impedance output
- half-DIN size cabinet
- 7 band graphic equalizer
- pre-amp input via RCA jacks
- output level control
- LED power level meter
- 12 dB boost/cut
- subwoofer frequency control
- subwoofer boost control
- front and rear fader control
- 6 channels RCA outputs

- 5 band graphic equalizer
- 5 band parametric controls
- 20 frequency band selectors
- pre-amp line & aux input
via RCA jacks
- output volume control
- input gain adjustments



- frequency gain control
- rotary fader
- rotary band control
- defeat switch
- 6 channels RCA outputs
- remote power on/off

specifications

ple730r

ple520p

ple730r
7-Band Equalizer**ple520p**
5-Band Equalizer**center frequencies**65 Hz · 150 Hz
400 Hz · 1.4 KHz
2.4 KHz · 6 KHz
15 KHz**sub band**

25 · 50 · 65 · 80 Hz

low band

150 · 200 · 260 · 300 Hz

low mid band

600 · 800 · 1000 · 1200 Hz

high mid band

2.1 · 2.8 · 3.5 · 4.2 KHz

high band

7 · 9.5 · 12 · 15 KHz

frequency response ——— 15 Hz - 30 KHz (+/- 1 dB) ———**input level** 400 mV 200 mV
(for 400mV output)**total harmonic distortion (THD)** ——— < 0.03% ———
(at 400mV output)**output impedance** ——— 10K Ohms ———**signal-to-noise ratio (S/N)** ——— 90 dB ———**separation** ——— 50 dB ———**current drain** ——— 450 mA ———**power supply voltage** ——— 12V DC Neg. Ground ———**dimensions (W x H x L)**
mm ——— 190 x 29 x 140
inches ——— 7 x 1.1 x 5.5

PYLE PLUS[®]

features and controls

ple730r

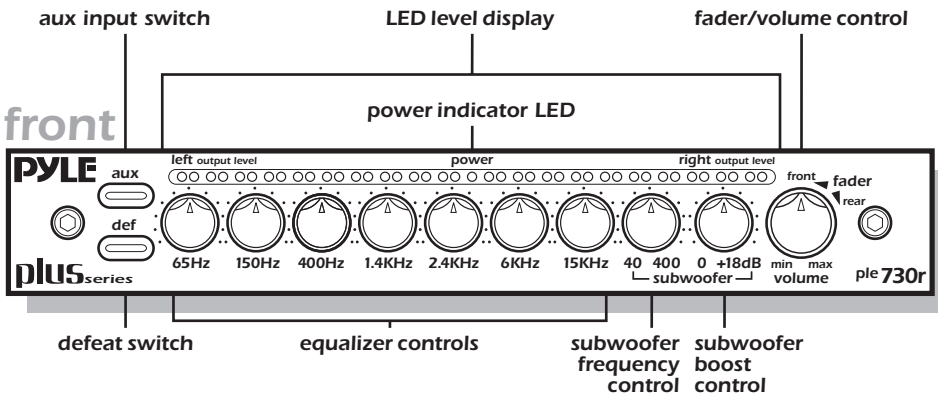

rear

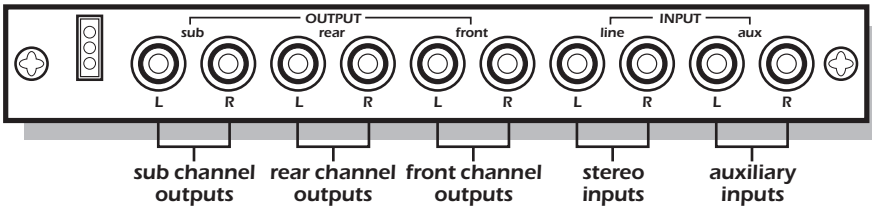

features

aux input switch the switch selects the aux or line inputs.

LED level display these rows of LEDs display the Preamp Output Levels. Left and right channels are displayed independently at peak levels.

power indicator LED this LED is illuminated when the unit is properly powered, grounded and the remote power has been turned on.

fader control

- in a 2 Amplifier, 4 Speaker system, rotating the knob to the FRONT side increases the level of the front speakers; rotating to the REAR side increase level of the rear speakers. At mid position, both sets of speakers are at maximum level.

- in a 2 Speaker system, the fader control should be rotated to the position which provides highest levels for both sets of speakers.

volume control allows adjustment of sound level for particular program material or source.

defeat switch when the "DEF" switch is in the position, the equalizer functions are bypassed. Depressing the "DEF" switch again will restore the equalizer's operation.

equalizer controls this seven-band equalizer gives you control over the output levels at various frequencies.

subwoofer frequency control lets you adjust the subwoofer frequency and crossover point from 40-400 Hz.

subwoofer boost control lets you adjust the subwoofer boost level from a 0 to +18 dB increase.

power connections connect to power source as follows:

+12V: Connect a red wire of at least 12 gauge to the car battery or other power source.

GROUND: Connect a black wire of at least 12 gauge to car chassis for ground connection

REMOTE: Connect an orange wire to remote activating (12V DC) wire of car stereo or other head unit.

subwoofer/rear/front channel outputs RCA cables are used to connect the subwoofer channel outputs to the subwoofer channel amplifier inputs, the rear channel outputs to the rear channel amplifier inputs, and the front channel outputs to the front channel amplifier inputs.

line and auxiliary inputs RCA cables are used to connect your car stereo head unit, CD player, or other source to either the line or aux inputs.

PYLE PLUS[®]

features and controls

ple520p

top

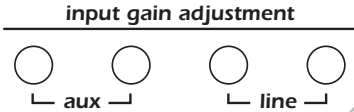

equalizer center frequency switches

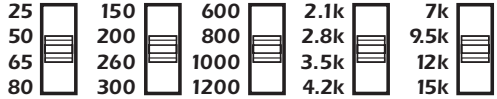

front

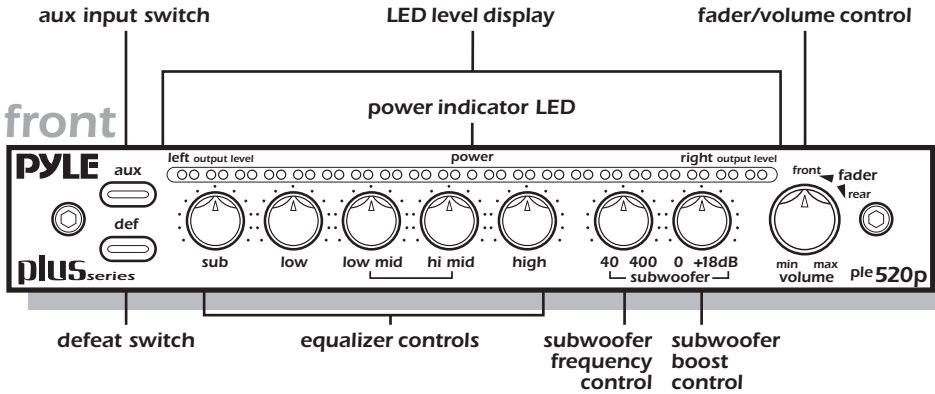

rear

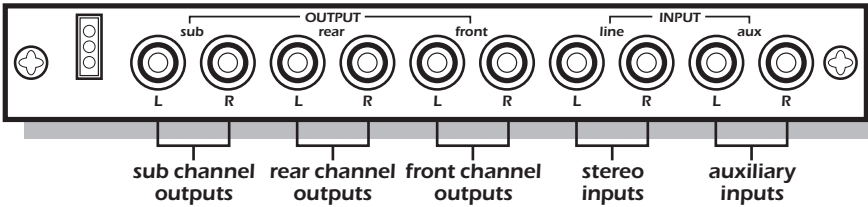

features

- input gain adjustments** allows you to adjust the left and right channel input sensitivity to match the output level from your line or auxiliary source.
- equalizer frequency controls** these switches determine the frequencies the equalizer control knobs on the front panel will affect. Setting a switch on one of the 5 bands on top of the equalizer permits the corresponding control on the front panel to boost or cut the level.
- aux input switch** the switch selects the aux or line inputs.
- LED level display** these rows of LEDs display the Preamp Output Levels. Left and right channels are displayed independently at peak levels.
- power indicator LED** this LED is illuminated when the unit is properly powered, grounded and the remote power has been turned on.
- fader control**
- in a 2 Amplifier, 4 Speaker system, rotating the knob to the FRONT side increases the level of the front speakers; rotating to the REAR side increase level of the rear speakers. At mid position, both sets of speakers are at maximum level.
 - in a 2 Speaker system, the fader control should be rotated to the position which provides highest levels for both sets of speakers.
- volume control** allows adjustment of sound level for particular program material or source.
- defeat switch** when the "DEF" switch is in the position, the equalizer functions are bypassed. Depressing the "DEF" switch again will restore the equalizer's operation.
- equalizer controls** this seven-band equalizer gives you control over boost or cut at the frequencies selected by the corresponding center frequency switches on top of the unit.
- subwoofer frequency control** lets you adjust the subwoofer frequency and crossover point from 40-400 Hz.
- subwoofer boost control** lets you adjust the subwoofer boost level from a 0 to +18 dB increase.
- power connections** connect to power source as follows:
- +12V: Connect a red wire of at least 12 gauge to the car battery or other power source.
 - GROUND: Connect a black wire of at least 12 gauge to car chassis for ground connection
 - REMOTE: Connect an orange wire to remote activating (12V DC) wire of car stereo or other head unit.
- subwoofer/rear/front channel outputs** RCA cables are used to connect the subwoofer channel outputs to the subwoofer channel amplifier inputs, the rear channel outputs to the rear channel amplifier inputs, and the front channel outputs to the front channel amplifier inputs.
- line and auxiliary inputs** RCA cables are used to connect your car stereo head unit, CD player, or other source to either the line or aux inputs.

mounting and installation

ple730r

ple520p

Please take the time to install your new Pyle Signal Processor securely, according to this diagram, using the hardware provided.

This Half-DIN size unit can also be installed in the dash adjacent to the head unit, provided that there is a slot available.

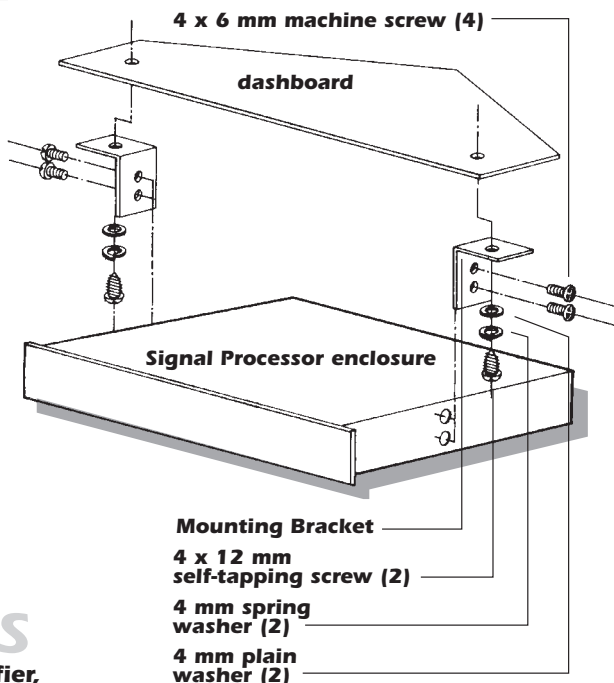

When making electrical connections to your amplifier, please observe the following:

Connect 12V DC from a constant battery source to a +12V slip-on spade terminal and install a one (1) amp fuse in line.

Connect the signal processor's GROUND to a good chassis ground, near where the unit is mounted, or to the case of the head unit.

Connect the signal processor's REMOTE TURN-ON lead to the remote turn-on lead out of the head unit, and install a 1/2 amp fuse in line. (A relay should be used if turning on more than one component, such as EQs, crossovers or amplifiers.)

Connect stereo RCA cables from the head's left and right front outputs to the left and right inputs of the signal processor.

Connect stereo RCA cables from the left and right outputs, (and low, mid and high outputs if applicable), of the signal processor to the left and right inputs of your amplifier(s) or additional signal processor(s).

Turn the unit on, and adjust the input gain on the signal processor to match the output of the head unit (1/2, or at center position, is about 1 V). Be careful not to overdrive the input of your amplifier(s) or signal processor(s).

Adjust each of the crossover or equalizer controls to achieve the desired sound characteristics.

electrical connections

ple730r

ple520p

rear

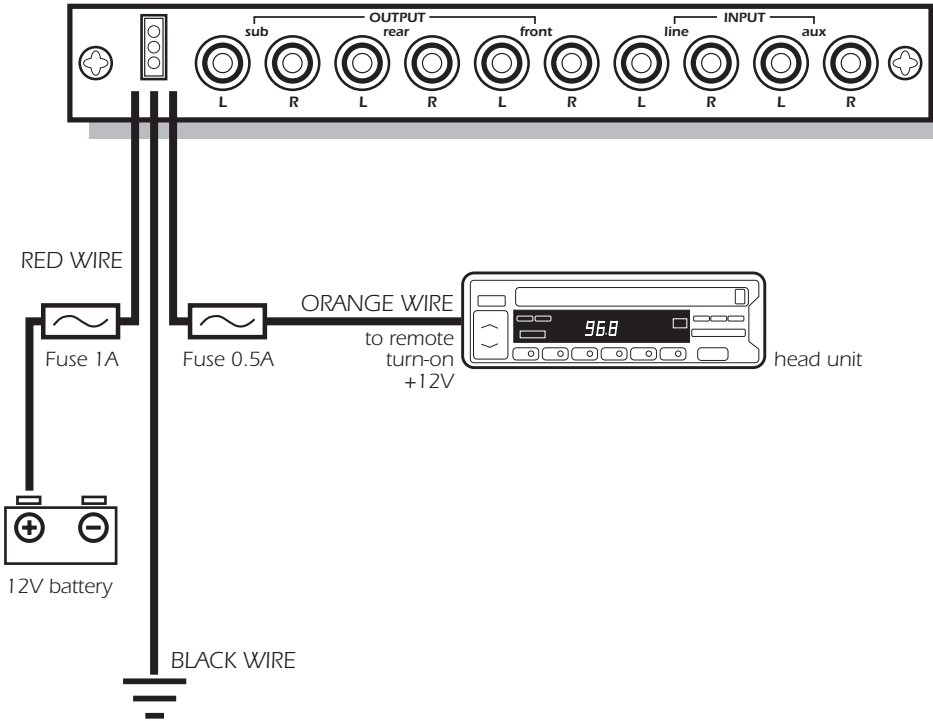

system wiring

ple730r

ple520p

basic system application using
front, rear, and subwoofer amps

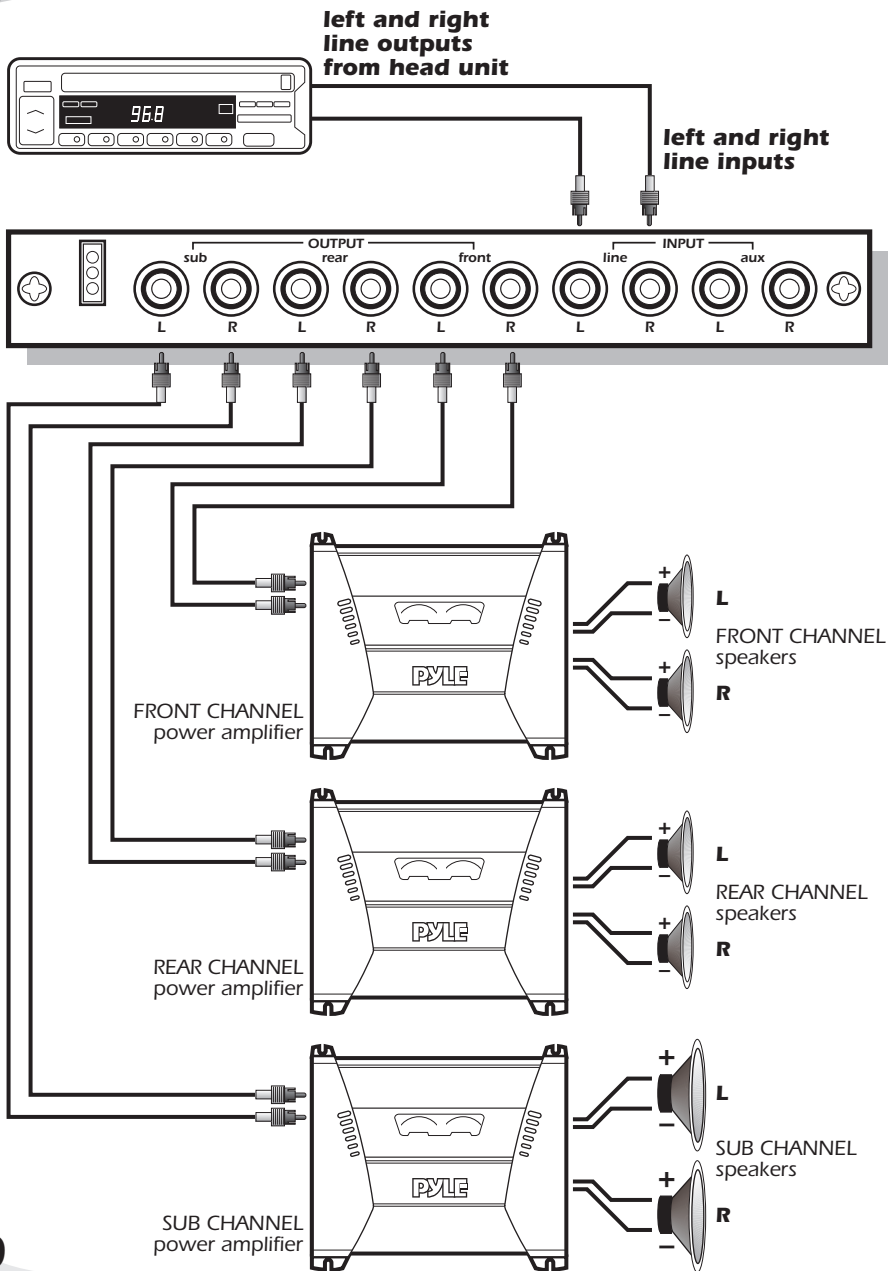

system wiring

basic system application using
a **4 channel amp** and **subwoofer amp**

ple730r

ple520p

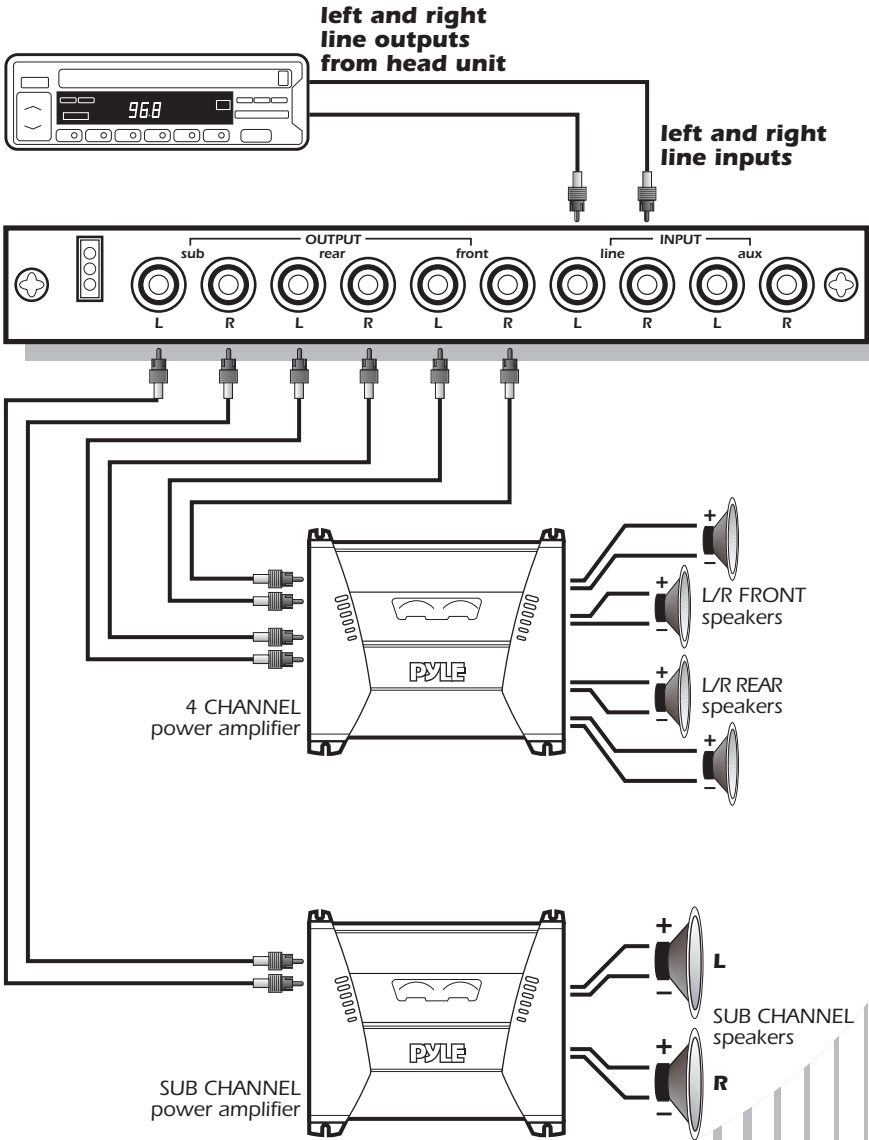

PYLE® STATUS

precautions

ple730r

ple520p

- Never drive with the volume raised so high you cannot hear what is occurring in traffic around you.
- Be aware that repeated exposure to excessive volume levels can permanently damage your hearing!
- Keep all electronics away from moisture, dust, extreme heat or extreme vibrations.
- Pyle Audio products are capable of sound pressure levels in excess of 150 dB. Continuous exposure to sound pressure levels over 100 dB may cause permanent loss of hearing. Use common sense and PRACTICE SAFE SOUND.

troubleshooting

If you experience...

Signal Processor does not turn on. Check that:

- Remote Turn-On wire has 12V.
- 12V wire has 12V.
- Ground wire is properly connected.

Level of sound is low. Check that:

- Wiring is not loose or cables misconnected/disconnected.
- RCA cables are not faulty.

Background noise is too high. Check that:

- Wiring is not loose or cables misconnected/disconnected.
- RCA cables are not faulty.

notes

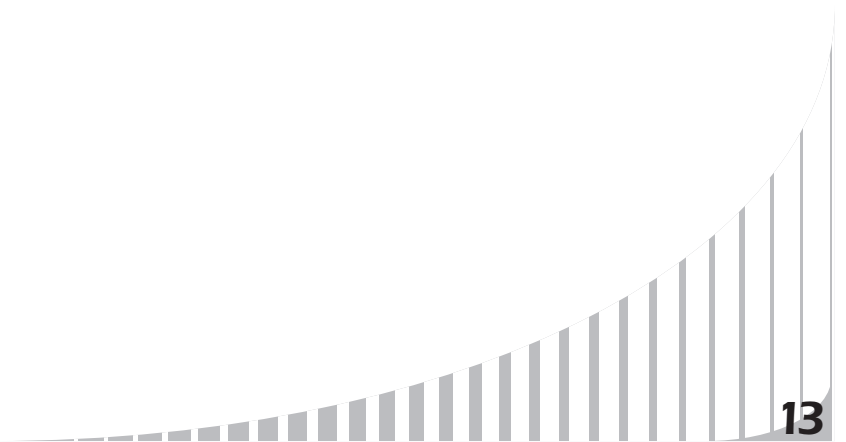

limited warranty policy

All Pyle products are carefully constructed and thoroughly tested before shipment. Products purchased in the USA are warranted to be free of defects in material and workmanship for two (2) years from the date of purchase. This warranty is limited to the original retail purchaser.

Should the product fail due to factory defects in material or workmanship, your unit will be repaired or replaced at the sole discretion of Pyle.

To obtain warranty service you must first call our Consumer Return Hotline number at (718) 236-6948 to obtain a Return Authorization number. This R.A.# must appear on the outside of your package and on all paperwork relating to your return.

When returning a product to us for warranty service it must be carefully packed and shipped prepaid to:

R.A.#
Pyle Service Center
1600 63rd Street
Brooklyn, NY 11204

You must also include the following items:

- A copy of your sales receipt or other proof of purchase
- A brief letter indicating the problem you are experiencing
- include in your letter your return address, daytime phone number, and R.A. number
- also include a check or money order for \$12.00 for return shipping, handling, and insurance, or provide your Visa/MC number with expiration date.

Our obligation under this warranty is limited to the repair or replacement of the defective unit when it is returned to us prepaid. This warranty will be considered void if the unit was tampered with, improperly serviced, or subject to misuse, neglect, or accidental damage.